

# AIRBRUSH PARTS

● HB-040

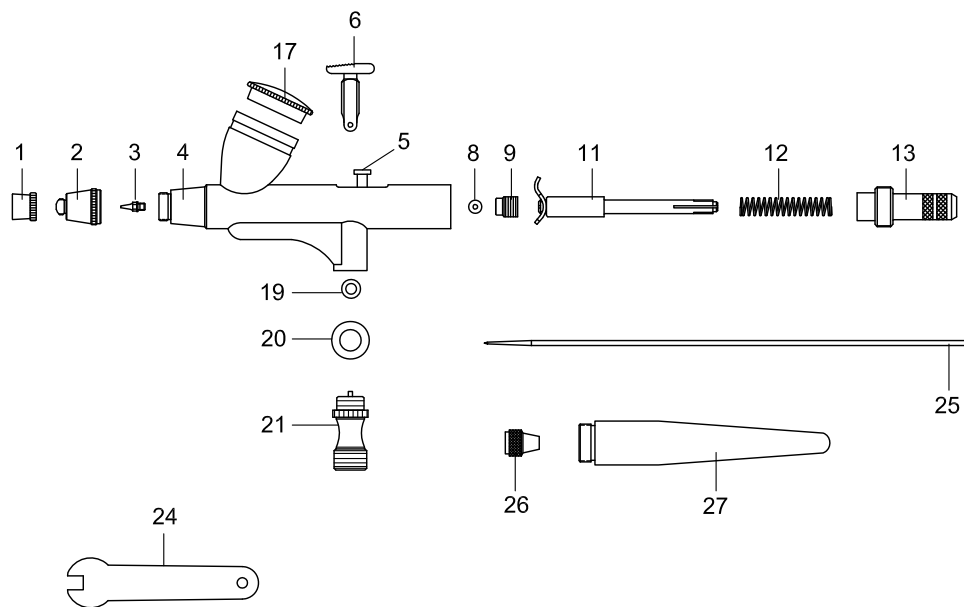
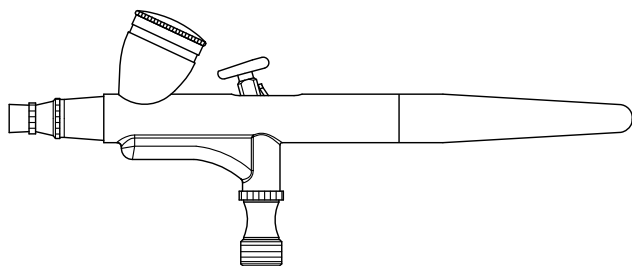

NOTE: See [www.SPARMAXair.com](http://www.SPARMAXair.com) for other airbrush models.

INDEX	DESCRIPTION	INDEX	DESCRIPTION	INDEX	DESCRIPTION
1	Needle cap	9	Needle guide	21	Air valve
2	Nozzle cap	11	Needle chucking guide	24	Wrench
3	Nozzle	12	Spring	25	Needle
4	Body	13	Spring case	26	Needle chucking nut
5	Piston	17	2cc cup cover	27	Handle
6	Push button	19	Piston o-ring		
8	O-ring for needle guide	20	Air valve o-ring		

HB-040-01-3511022C  
2020/05

# OPERATING INSTRUCTIONS

## AIR PRESSURE

The fluidity of the paint will have an effect on what is the ideal pressures to use, so if you are able to vary your working air pressure, the best advice, is to experiment.

## PAINT PREPARATION

Whatever kind of paint you use, make sure that it's a milky consistency, you may have to mix some paints with water or a solvent to achieve this. It is best to prepare the paint relatively thin and make repeated passes across the artwork to achieve the desired shade. There are many different types of inks and water colors available that can be used straight from the bottle and are ideal for airbrush work.

## OPERATING YOUR AIRBRUSH - pix①

For dual action models, this design allows you to control air and color supplies totally independently, so you can achieve a vast range of different effects and finishes. The double-action refers to the push button, press down for air, pull back for paint. The further the push button is pressed down, the stronger the air force, the further the push button is pulled back, the greater the amount of paint. The balancing act of blending the right amount of air and paint comes with experience.

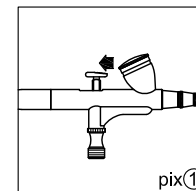

## THE START

With dual action airbrushes there is a "golden rule" operation - "AIR ON FIRST, AIR OFF LAST". The key is to start off spraying with air only, the situation you must avoid at all costs is "PAINT ON, AIR OFF" - that is, the push button pulled back but not depressed, in this case, paint accumulates on the needle and sits there waiting for the air to arrive. When it does, the paint simply splats onto your artwork. Always press the push button down before you pull it back, and when you stop spraying make sure the push button is fully returned to its original position before lifting your finger off. Initially, when you start spraying with your airbrush, you should practice freehand spraying. Hold your airbrush, loaded with paint, about 7.5cm from the surface and just spray away, you'll soon pick up the behavioural patterns of your airbrush. After a while, try varying the spray by moving your airbrush to create finer and stronger lines, and further away for broader and weaker lines. The finer and stronger the line, the further away, the broader and weaker the line.

## A GOOD TIP FOR SPRAYING A CLEAN FINE LINE - pix②

Don't start by pointing the airbrush at the exact spot where you want the line to begin. Start earlier, moving smoothly towards the target point with air only. When you're in line with the point, pull back the lever for paint. Similarly, at the end of the line, switch off the paint but carry on for a second or two with air only.

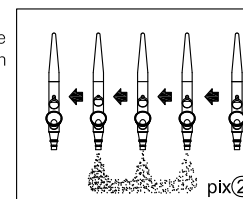

## \* CLEANING YOUR AIRBRUSH

Keeping your airbrush clean is the single most important aspect of owning an airbrush. The vast majority of airbrush problems are connected to the fact that the airbrush is simply blocked up or seized up through lack of regular thorough cleaning. Your airbrush needs to be cleaned between every color change by flushing through water or a cleaning agent and paint should never be allowed to stand idle in the color cap.

## PROCEDURES FOR CLEANING: - pix③

1. Loosen the needle chucking nut and pull the needle back a bit.
2. Add a few drops of water or cleaning solution.
3. Place your finger or a piece of cloth over the needle cap and blow a little air through to produce backspray into paint passage. This will dislodge any paint residue from the nozzle and the paint passage.
4. Clean the color cup with a Q-tip.
5. Flush out the airbrush with water or cleaner.

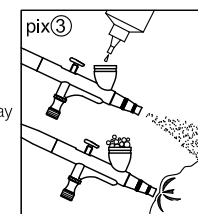

## \* CLEANING NEEDLES & NEEDLE CAPS

Especially with pigmented colors, paint will build up on the needle and on the inside of the needle cap. Both parts must, therefore, be cleaned frequently.

## PROCEDURES FOR CLEANING: - pix④ / pix⑤

1. Remove the needle and draw it gently across a piece of soft cloth or a sheet of blotting paper away from the tip, rotating it as you go.
2. Unscrew the needle cap and clean the inside with a Q-tip and water or Airbrush cleaner.
3. Check the Nozzle from time to time to ensure it is not damaged, only remove it when it needs replacing.
4. Replace needle cap.
5. Carefully insert the needle, pushing it with slight pressure against the nozzle with a little rotating movement to ensure a proper seat. Finally tighten the needle chucking nut.

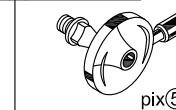
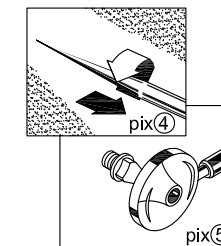

## MAINTENANCE & TROUBLESHOOTING

There are three steps you should take as your starting point when carrying out maintenance work on your airbrush.

1. Make sure you have the diagrammatic breakdown and part list of your airbrush at hand, showing all the internal parts. It will enable you to specify a new part should you need one.
2. Choose a work surface that is flat and well lit, it helps to have a magnifying glass at hand for inspecting minute components.
3. Most important of all, if you're not sure what's wrong and don't know how to fix it, consult your dealer, it can be all too easy to make an expensive mistake. Apart from the specific problems where it is indicated you should consult your dealer.